

# SHARJAH HEALTHCARE CITY STANDARD COMPONENTS

Room Layout Sheet

Room Name **Waste Compactor/Recyclables**

RLS Room Code **WACO-SJ**  
RDS Room Code **WACO-SJ**

DP DOOR AND FRAME PROTECTION  
GPO/S GENERAL POWER OUTLET SPECIAL - SINGLE  
OP OBSERVATION PANEL

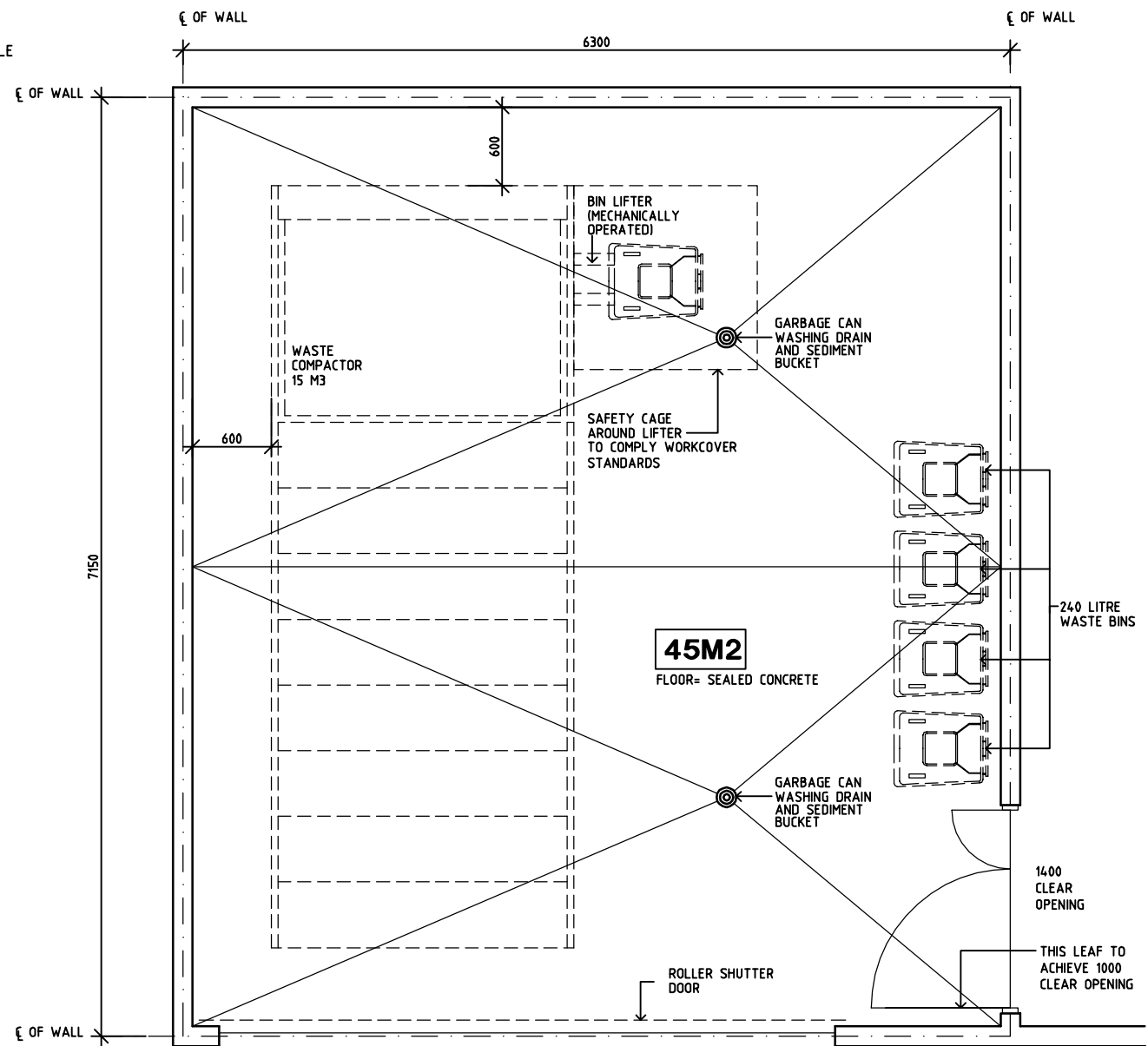

**PLAN**

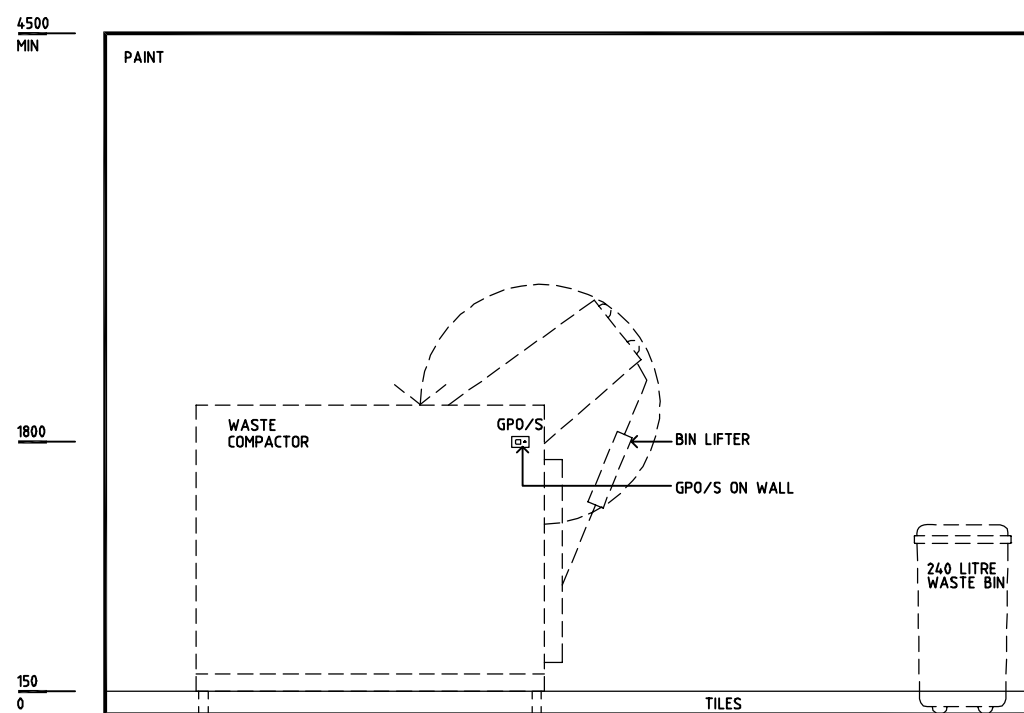

**ELEVATION 1**

REV	DESCRIPTION	DATE	BY	REV	DESCRIPTION	DATE	BY	REV	DESCRIPTION	DATE	BY
1	FIRST ISSUE	14.03.2014	AA								



Sharjah Health Facility Guidelines at:  
www.healthdesign.com.au/shcc/hfg  
Editable version of Standard Components on  
Health Facility Briefing System (HFBS) at:  
www.healthdesign.com.au  
Provided by TAHPI

DESIGNED	APPROVED	DATE	SCALE(S)	SHEET
CC	DB	30.12.13	1:50 in A3	1 of 3
CAD FILE NAME		PAPER DRAWING ID		ISSUE
WACP-SJ		WACO-SJa		1

This document is for advisory purpose only

# SHARJAH HEALTHCARE CITY STANDARD COMPONENTS

Room Layout Sheet

Room Name **Waste Compactor/Recyclables**

RLS Room Code **WACO-SJ**  
RDS Room Code **WACO-SJ**

DP DOOR AND FRAME PROTECTION  
GPO/S GENERAL POWER OUTLET SPECIAL - SINGLE  
OP OBSERVATION PANEL

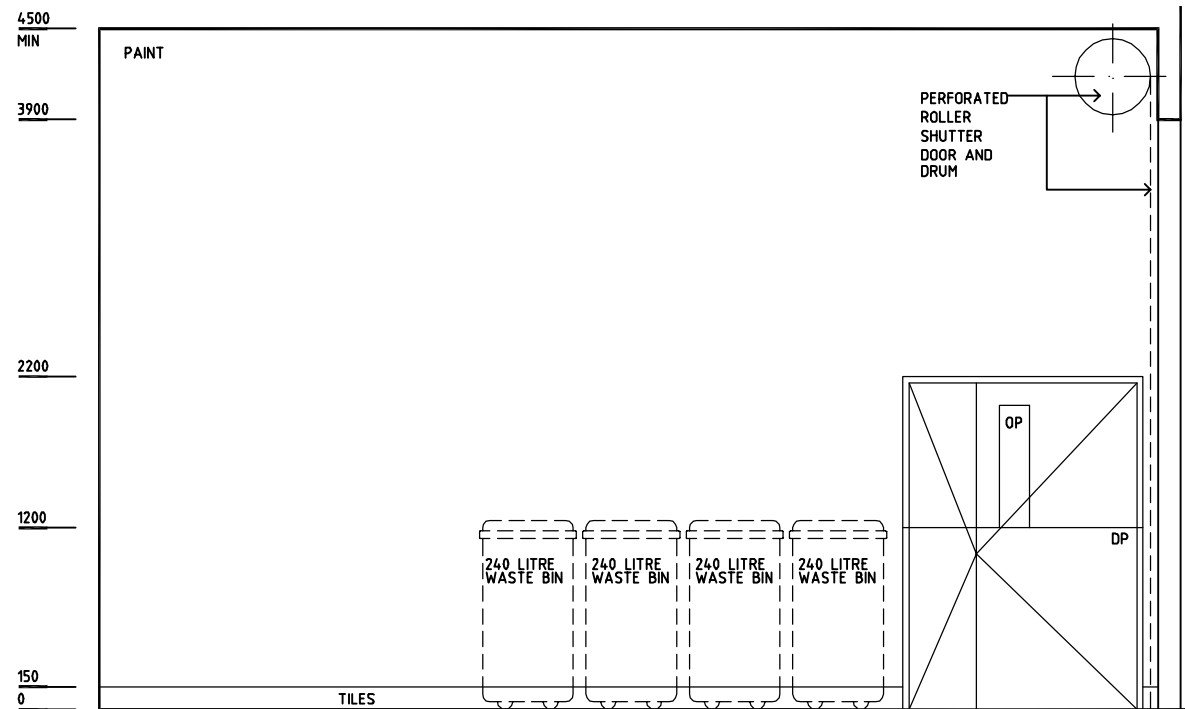

**ELEVATION 2**

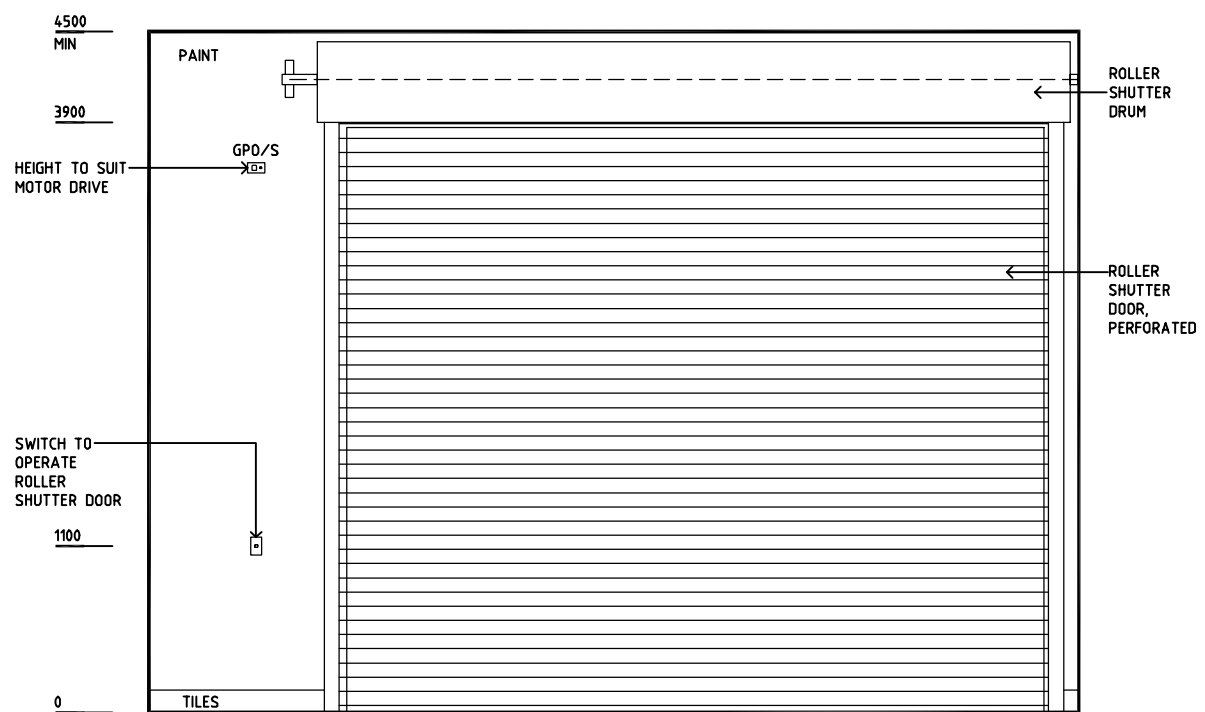

**ELEVATION 3**

REV	DESCRIPTION	DATE	BY	REV	DESCRIPTION	DATE	BY	REV	DESCRIPTION	DATE	BY
1	FIRST ISSUE	14.03.2014	AA								

 <b>SHCC Guidelines</b>	Sharjah Health Facility Guidelines at: <a href="http://www.healthdesign.com.au/shcc/hfg">www.healthdesign.com.au/shcc/hfg</a> Editable version of Standard Components on Health Facility Briefing System (HFBS) at: <a href="http://www.healthdesign.com.au">www.healthdesign.com.au</a> Provided by TAHPI		DESIGNED	APPROVED	DATE	SCALE(S)	SHEET
	CC	DB	30.12.13	1:50 in A3	2 of 3		
	CAD FILE NAME		PAPER DRAWING ID		ISSUE		
WACP-SJ		WACO-SJb		1			

This document is for advisory purpose only

# SHARJAH HEALTHCARE CITY STANDARD COMPONENTS

Room Layout Sheet

Room Name **Waste Compactor/Recyclables**

RLS Room Code **WACO-SJ**

RDS Room Code **WACO-SJ**

DP DOOR AND FRAME PROTECTION  
 GPO/S GENERAL POWER OUTLET SPECIAL - SINGLE  
 OP OBSERVATION PANEL

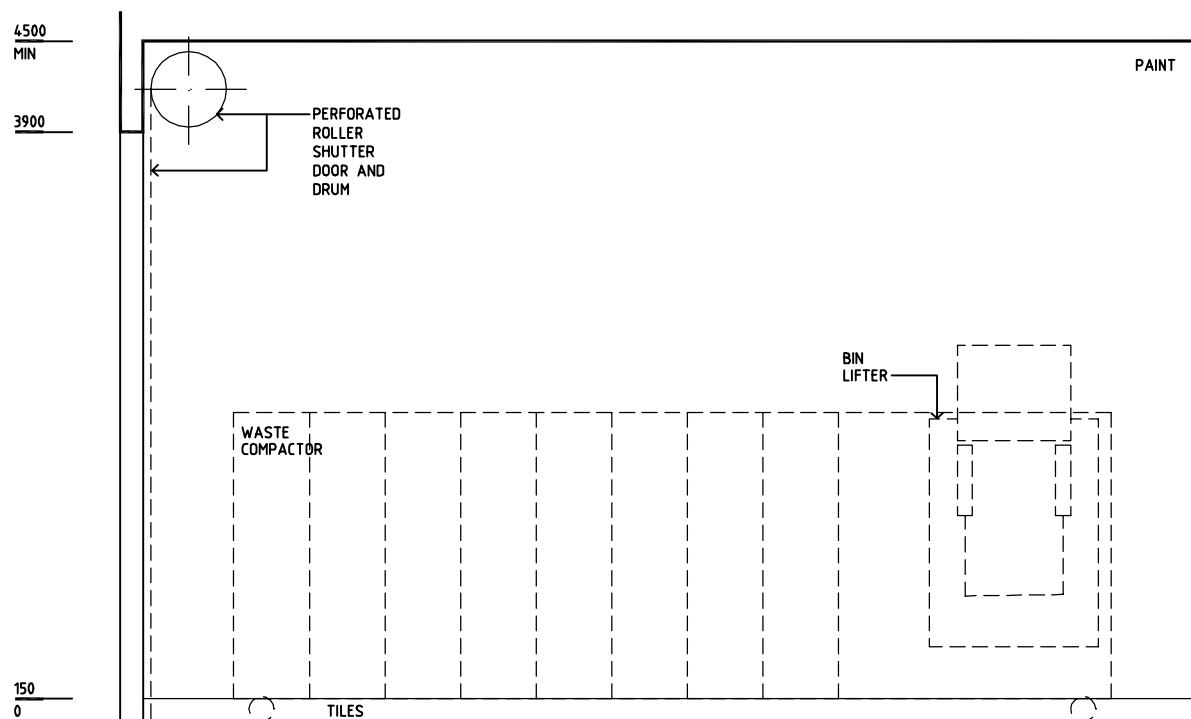

**ELEVATION 4**

REV	DESCRIPTION	DATE	BY	REV	DESCRIPTION	DATE	BY	REV	DESCRIPTION	DATE	BY
1	FIRST ISSUE	14.03.2014	AA								

 <b>SHCC Guidelines</b>	Sharjah Health Facility Guidelines at: <a href="http://www.healthdesign.com.au/shcc/hfg">www.healthdesign.com.au/shcc/hfg</a> Editable version of Standard Components on Health Facility Briefing System (HFBS) at: <a href="http://www.healthdesign.com.au">www.healthdesign.com.au</a> Provided by TAHPI		DESIGNED	APPROVED	DATE	SCALE(S)	SHEET
	CC	DB	30.12.13	1:50 in A3	3 of 3		
	CAD FILE NAME		PAPER DRAWING ID		ISSUE		
WACP-SJ		WACO-SJc		1			