

SHARJAH HEALTHCARE CITY STANDARD COMPONENTS

Room Layout Sheet

Room Name **Treatment Room - Renal Dialysis, Enclosed (Type A)**

RLS Room Code **TRMT-RD-S-I-SJ-A**
RDS Room Code **TRMT-RD-S-I-SJ**

- COM/2 COMMUNICATION OUTLET - DOUBLE
- DDG DISPENSER - DISPOSABLE GLOVES
- DHT DISPENSER - HAND TOWEL, PAPER
- DS DISPENSER - SOAP
- DSA DISPENSER - SOAP ANTISEPTIC
- EC EMERGENCY CALL
- GPO/1 GENERAL POWER OUTLET - SINGLE
- GPO/1 EP GENERAL POWER OUTLET - EMERGENCY POWER
- GPO/2 GENERAL POWER OUTLET - DOUBLE
- GPO/C GENERAL POWER OUTLET - CLEANER
- LS/B LIGHT SWITCH- BAY
- LS/R LIGHT SWITCH- ROOM
- MA MEDICAL AIR
- NA NURSE ASSIST CALL
- NC PATIENT/NURSE CALL
- O2 OXYGEN
- RCD RESIDUAL CURRENT DEVICE
- RO REVERSE OSMOSIS
- S SUCTION
- SBB SUCTION BOTTLE BRACKET
- SK4 FLOOR VINYL COVED SKIRTING
- V1 VINYL FLOORING, STANDARD
- WVS WALL VINYL SPLASHBACK

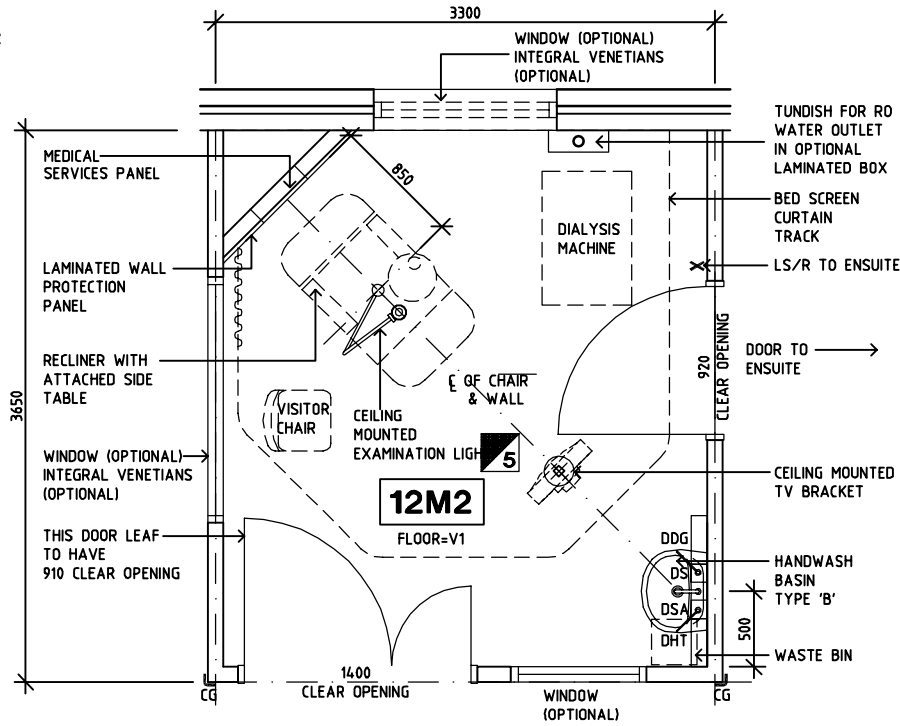

PLAN

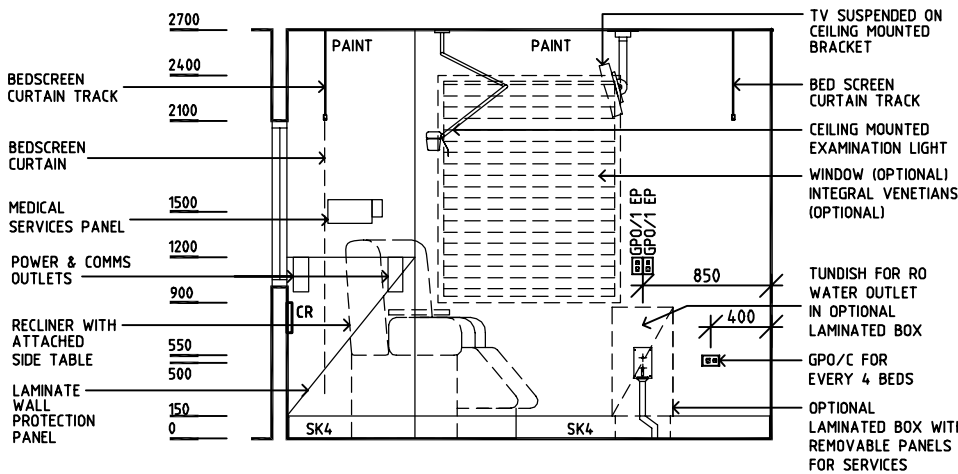

ELEVATION 1

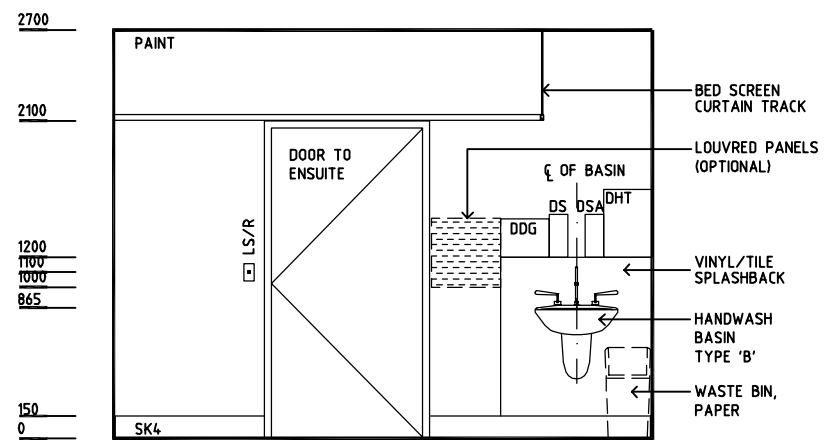

ELEVATION 2

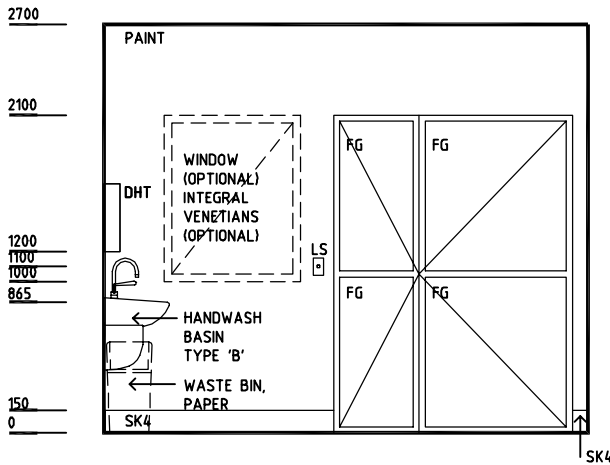

ELEVATION 3

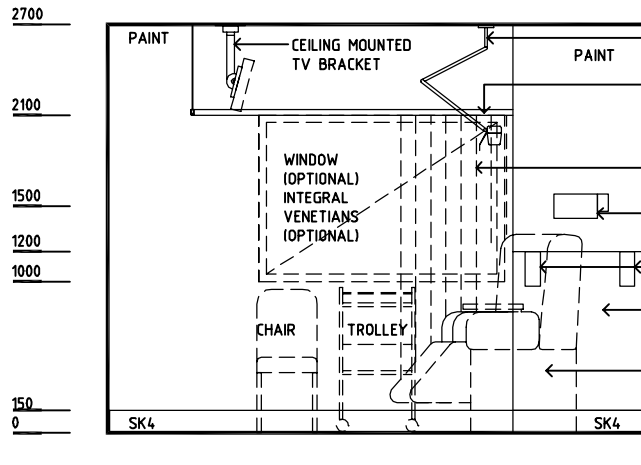

ELEVATION 4

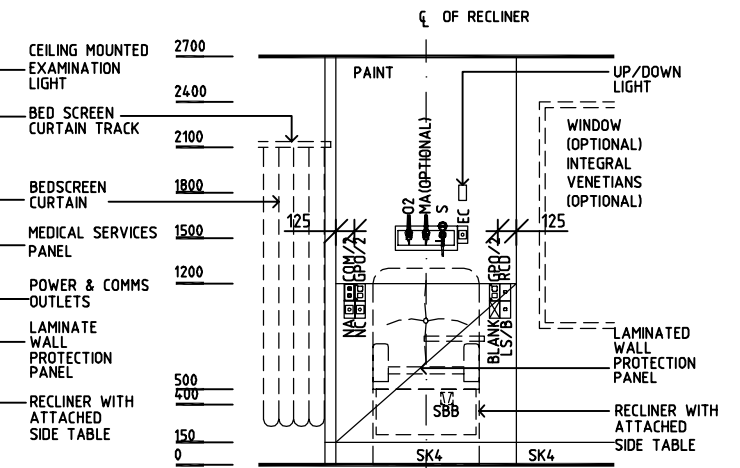

ELEVATION 5

REV	DESCRIPTION	DATE	BY	REV	DESCRIPTION	DATE	BY	REV	DESCRIPTION	DATE	BY
1	FIRST ISSUE	14.03.2014	AA								



Sharjah Health Facility Guidelines at:
www.healthdesign.com.au/shccfg
Editable version of Standard Components on
Health Facility Briefing System (HFBS) at:
www.healthdesign.com.au
Provided by TAHPI

DESIGNED	APPROVED	DATE	SCALE(S)	SHEET
CC	DB	30.12.13	1:50 in A3	1 of 1
CAD FILE NAME		PAPER DRAWING ID		ISSUE
TRMT-RD-S-I-SJ-A		TRMT-RD-S-I-SJ-A		1

This document is for advisory purpose only

SHARJAH HEALTHCARE CITY STANDARD COMPONENTS

Room Layout Sheet

Room Name **Treatment Room - Renal Dialysis, Enclosed (Type B)**

RLS Room Code **TRMT-RD-S-I-SJ-B**
RDS Room Code **TRMT-RD-S-I-SJ**

- COM/2 COMMUNICATION OUTLET - DOUBLE
- DDG DISPENSER - DISPOSABLE GLOVES
- DHT DISPENSER - HAND TOWEL, PAPER
- DS DISPENSER - SOAP
- DSA DISPENSER - SOAP ANTISEPTIC
- EC EMERGENCY CALL
- GP0/1 GENERAL PURPOSE OUTLET - SINGLE
- GP0/1 EP GENERAL PURPOSE OUTLET - EMERGENCY POWER
- GP0/2 GENERAL PURPOSE OUTLET - DOUBLE
- GP0/C GENERAL PURPOSE OUTLET - CLEANER
- LS/B LIGHT SWITCH- BAY
- LS/R LIGHT SWITCH- ROOM
- MA MEDICAL AIR
- NA NURSE ASSIST CALL
- NC PATIENT/NURSE CALL
- O2 OXYGEN
- RCD RESIDUAL CURRENT DEVICE
- RO REVERSE OSMOSIS
- S SUCTION
- SBB SUCTION BOTTLE BRACKET
- SK4 FLOOR VINYL COVED SKIRTING
- V1 VINYL FLOORING, STANDARD
- WVS WALL VINYL SPLASHBACK

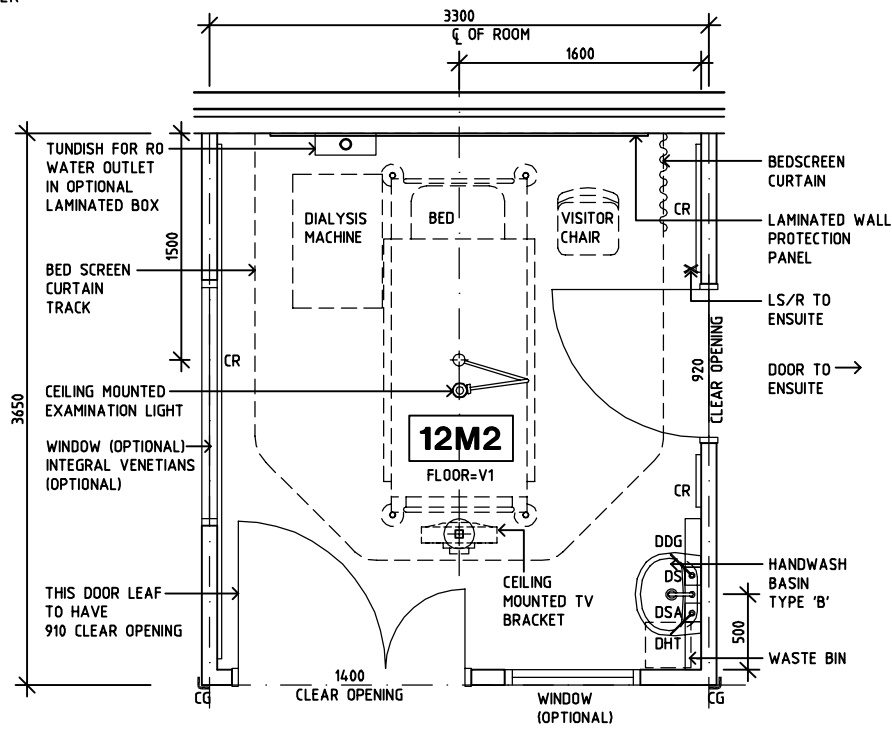

PLAN

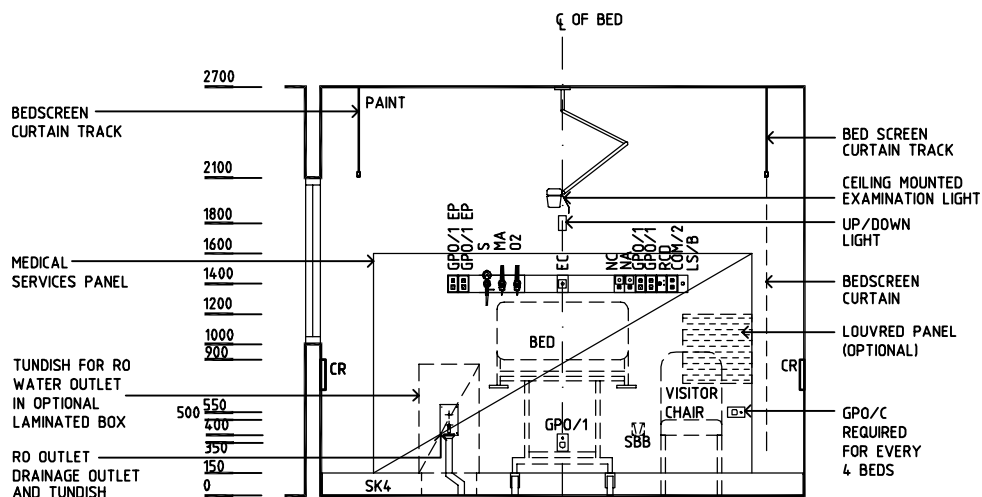

ELEVATION 1

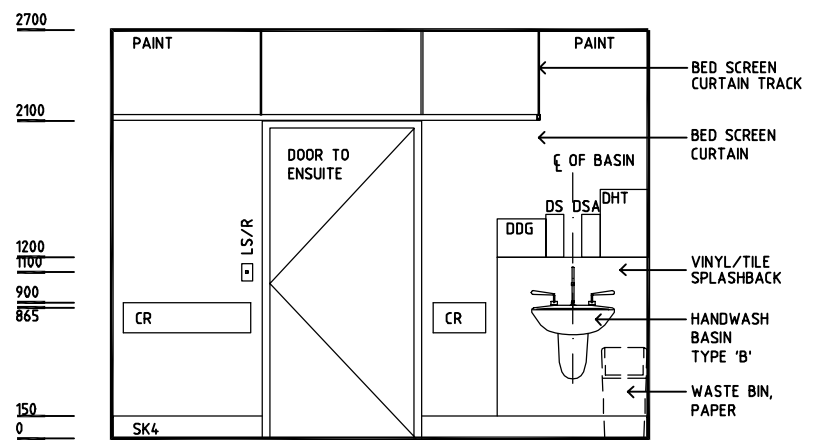

ELEVATION 2

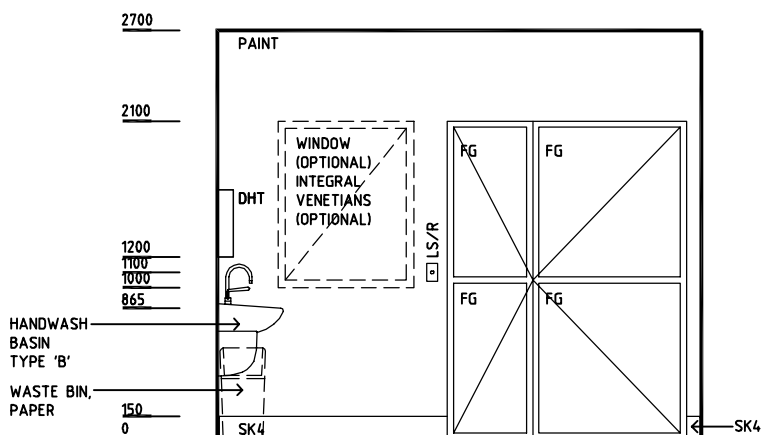

ELEVATION 3

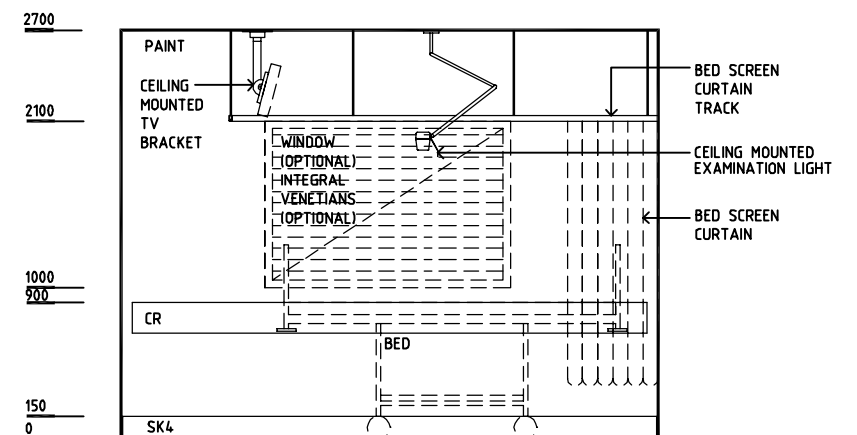

ELEVATION 4

REV	DESCRIPTION	DATE	BY	REV	DESCRIPTION	DATE	BY	REV	DESCRIPTION	DATE	BY
1	FIRST ISSUE	14.03.2014	AA								



Sharjah Health Facility Guidelines at:
www.healthdesign.com.au/shcc/hfg
Editable version of Standard Components on
Health Facility Briefing System (HFBS) at:
www.healthdesign.com.au
Provided by TAHPI

DESIGNED	APPROVED	DATE	SCALE(S)	SHEET
CC	DB	30.12.13	1:50 in A3	1 of 1
CAD FILE NAME		PAPER DRAWING ID		ISSUE
TRMT-RD-S-I-SJ-B		TRMT-RD-S-I-SJ-B		1

This document is for advisory purpose only