

NSW HFG PENDING STANDARD COMPONENTS

Room Layout Sheet

Room Name **Equipment Clean-Up, 8m2**

RLS Room Code **ECL-8**

RDS Room Code **ECL-8**

- AS ADJUSTABLE SHELF
- CP CHROME PLATED
- DDG DISPENSER - DISPOSABLE GLOVES
- DHT DISPENSER - HAND TOWEL
- DP DOOR AND FRAME PROTECTION
- DS DISPENSER - SOAP
- DSA DISPENSER - SOAP, ANTISEPTIC
- GPO/2 GENERAL PURPOSE OUTLET-DOUBLE
- LS LIGHT SWITCH
- OP OBSERVATION PANEL
- SK4 FLOOR VINYL COVERED SKIRTING
- V4 VINYL FLOORING, SAFETY

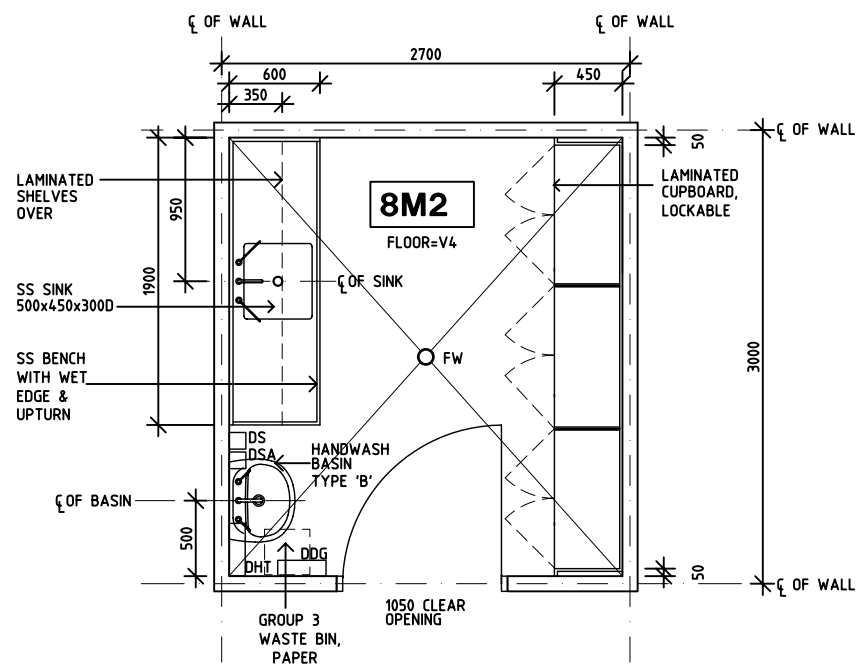

PLAN

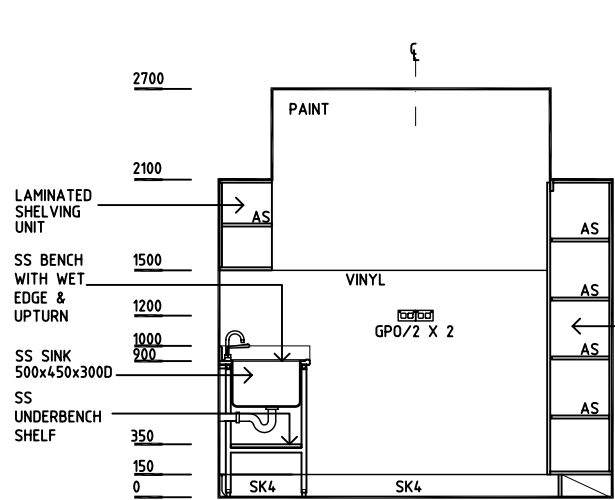

ELEVATION 1

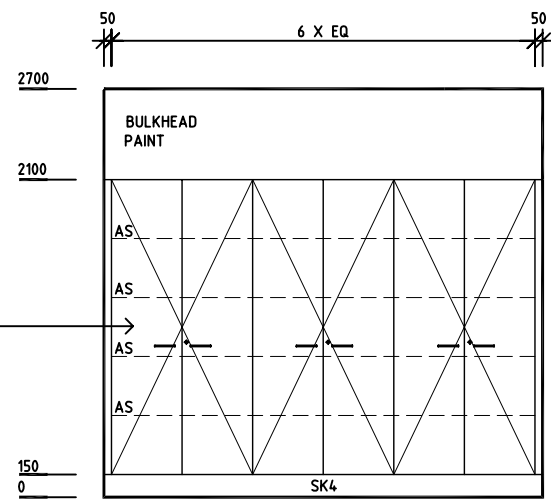

ELEVATION 2

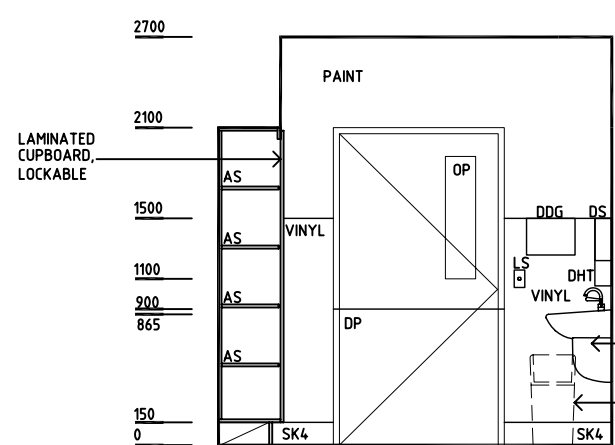

ELEVATION 3

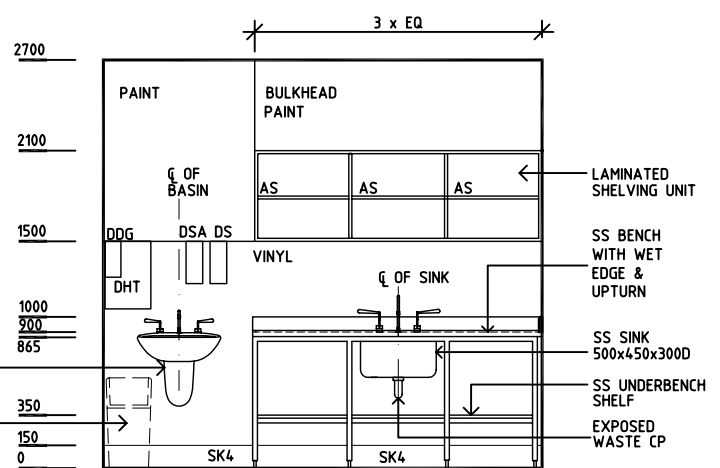

ELEVATION 4

REV	DESCRIPTION	DATE	BY	REV	DESCRIPTION	DATE	BY	REV	DESCRIPTION	DATE	BY
1	FIRST ISSUE	24.4.06	AL								